

DİKKAT

MONTAJ KİTAPÇIĞINI ÜRÜNÜN KULLANIM SÜRESİNCE MURAHAZA EDİNİZ.

- Montaj ile ilgili sorunlarınız ve işlemleriniz için, lütfen ürünü satın aldığınız yetkili satıcımıza danışınız.
- Montaj şemasını ve garanti belgesini, ödeme evraklarıyla birlikte saklayınız.
- Yedek parçaya ihtiyaç duyduğunuz takdirde, lütfen montaj kılavuzunda gösterilen olan parçaya kodlarına bakınız.

When Ordering Extra Parts, Do Not Forget to Mention Part Code.

MONTAJ KATALOĞU AÇIKLAMALARI

PARÇALISTESİNİN KONTROL EDİNİZ.

KUTUDAN ÇIKAN TÜM PARÇA VE AKSESUARLARI LİSTELERLE KARŞILAŞTIRINIZ. TAM VE SAĞLAM OLDUĞUNDAN SARTIYADIKTAN SONRA MONTAJA BAŞLAYINIZ.

ELİMLENİR GEREKENLER:

-EĞER BİRDEN FAZLA ÜRÜN ALDIYSANIZ HERHAANGİ BİR KARŞIĞIĞIĞA SEBEP VERMEK İÇİN TEK BİR ÜRÜNÜN MONTAJINI YAPTIKTAN SONRA DİĞER ÜRÜNÜ GEÇERLİZ.

-ÜRÜNLERİ HİÇBİR ZAMAN SONDANEREK TAŞIMAYINIZ ÜRÜNÜ KALDIRILMAYI VEYA SÖKÜLMÜ EN AZ İKİ KİŞİ İLE TAŞIYINIZ. UZUN MESAFELİ TAŞIMALARDA ÜRÜNÜ MÜLTİPLA PAKETİ İÇİNDE TAŞIYINIZ.

-MONTAJ BAŞLAMADAN ÖNCE BEZLER PARÇA VE AKSESUARLARI GRUPLANDIRINIZ.

-TÜM MOBİLYALAR AŞIRI NEM, SICAK SUDAKTAN ETKİLENDİKLERİNDEN, MOBİLYANIZ BU FAKTÖRLERLE DİREK İLAKA OLARAK TEMAS ETTİRMEYİNİZ. MONTAJ BAŞLAMADAN ÖNCE HER PARÇAYI NEMLİ BİR BEZ İLE SİLİNEREK TEMİZLEYİNİZ.

-TÜM VİDALARI SAĞLAM SAĞA DOĞRU YAYIĞA GEYERİNİZ HİÇBİR ZAMAN ÇOK SIKARAK ZORLAMAYINIZ.

-MOBİLYANINIZI YAŞ TOPRAK GİBİ ÇİZGİ İLADELENERİZ UZAK TUTUNUZ. DOZGÜN VE AYDINLIK BİR ORTAMDA MOKÜN İSE BİR HAL ÜZERİNDE MONTA EDİNİZ.

-ÜRÜNLERİMİZİN MONTAJ ESMASINDA ZARAR GÖRMEK İÇİN MONTAJI MÜLTİPLA İKİ KİŞİ TARAFINDAN YAPINIZ.

-HER PARÇAYI DİKKATLİCE İNCELEYİP MÜLTİPLA MONTAJ KATALOĞUNDAKİ KURALLARA UYARAK YAPINIZ.

-ÇUKKA İŞLENİME PARÇALARI DELİKLERE HAFİFCE TIKLATILMAYI KULLANMAYINIZ.

-TEMİZLİK İÇİN SADECE SU İLE HAFİF NEMLENDİRİLMİŞ PAMUKLU BEZ KULLANINIZ VE KURULAYINIZ.

-MOBİLYANIZI AMAÇSIZ OLARAK KULLANMAYINIZ.

-KAPAK, ÇERÇEME VE HAREKETLİ PARÇALARIN SAĞLIKLI ÇALIŞABİLME İÇİN SERT HABEKTERDEN KAÇININIZ.

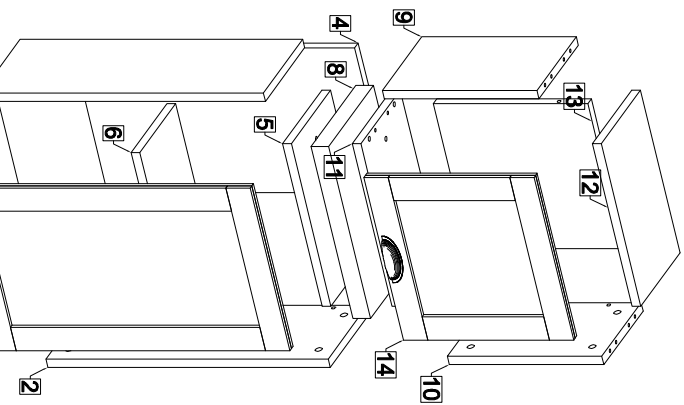

PARÇA NO.:	PARÇA ADI.:	ADET	PARÇA KODU	PARÇA NO.:	PARÇA ADI.:	ADET	PARÇA KODU
1	ALT BLOK TABLA	1	*	12	ÜST BLOK ÜST TABLA	4	*
2	ALT BLOK SAĞ YAN TABLA	1	*	13	ÜST BLOK ARKA PANO	1	*
3	ALT BLOK SOL YAN TABLA	1	*	14	ÜST BLOK KAPAK	1	*
4	ALT BLOK ARKA PANO	1	*	15		1	*
5	ALT BLOK ÜST TABLA	1	*	16		1	*
6	ALT BLOK RAF	1	*	17		1	*
7	ALT BLOK KAPAK	1	*	18		1	*
8	ORTA RAF	2	*	19		1	*
9	ÜST BLOK SOL YAN TABLA	4	*	20		1	*
10	ÜST BLOK SAĞ YAN TABLA	4	*	21		1	*
11	ÜST BLOK ALT TABLA	4	*	22		1	*

RAHMETLİ FİREÇELE	RAH FİMLİ	RENKLEMLİ DİNE MENİŞE	RENKLEMLİ DİNE MENİŞE	RENKLEMLİ DİNE MENİŞE	64 LÜK ÇAMAK KULUŞ	630 KASNA VİDASI	30MM AĞIR KAK	3.5X7.8 SİVAH YAKK	3.5X25 SİVAH YAKK	3.5X25 SİVAH YAKK	VIDA M22	M23 VİDA	PLASTİK KEMERDEN	14" KEMERDEN
P	O	N	M	L	K	J	H	G	F	E	D	C	B	A

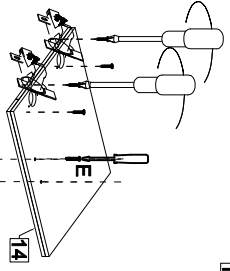
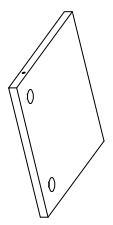
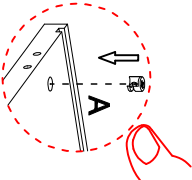
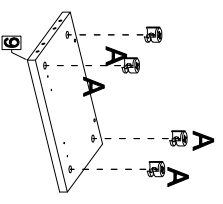
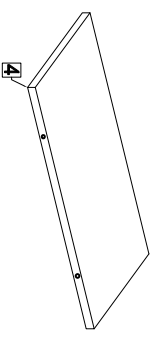
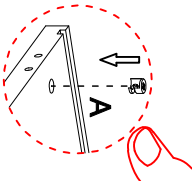
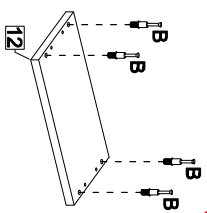
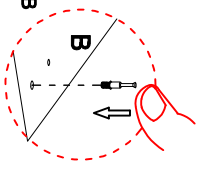
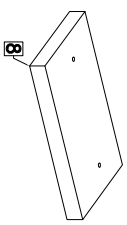
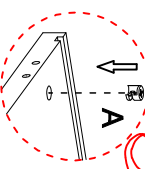
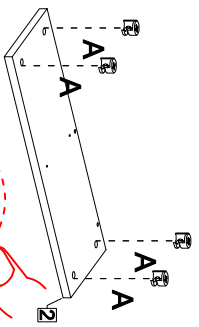
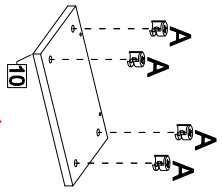
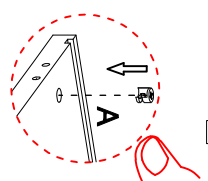
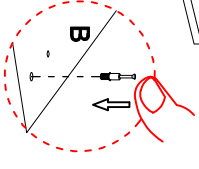
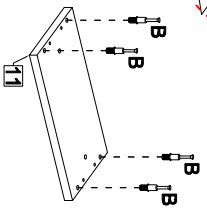
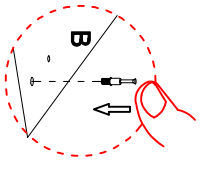
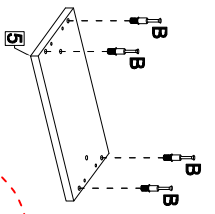
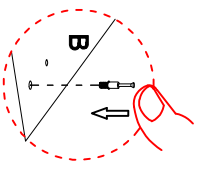
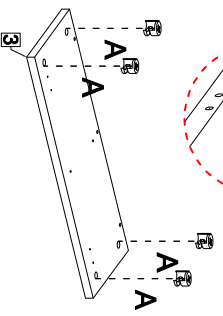
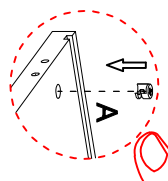
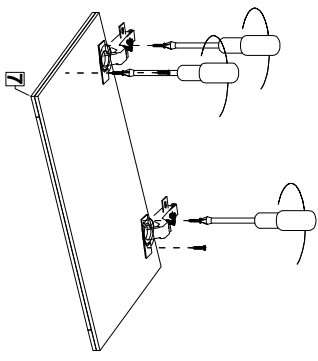
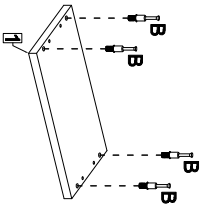
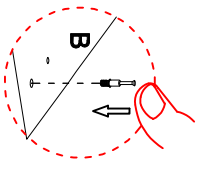

M	H	E	C	B	A

DİKKAT MONTAJ KİTAPÇIĞINI ÜRÜNÜN KULLANIM SÜRESİNCE MUHAFAZA EDİNİZ.

